

➤ Applicable Models:  
TA-SA\*\*\*\*.F

➤ Use on Discover Teacher Desks,  
Discover Shape Tables &  
Discover Shape Student Desks

**DISCOVER TEACHER DESKS**

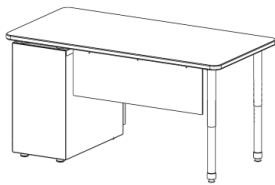

12" h Modesty Screen

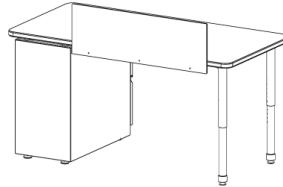

12" h Privacy Screen

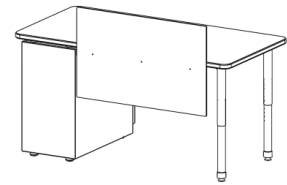

22" h Combination Screen

Discover Teacher Desks	Single Pedestal			Double Pedestal	
	48" w	60" w	72" w	60" w	72" w
Number of Brackets	2	3	4	2	3
Modesty Screen Size	24.25 x 12"	36.25" x 12"	48.25" x 12"	24.25 x 12"	36.25" x 12"
Privacy Screen Size	24.25 x 12"	36.25" x 12"	48.25" x 12"	24.25 x 12"	36.25" x 12"
Combo Screen Size	24.25 x 22.5"	36.25" x 22.5"	48.25" x 22.5"	24.25 x 22.5"	36.25" x 22.5"

**DISCOVER SHAPE TABLES**

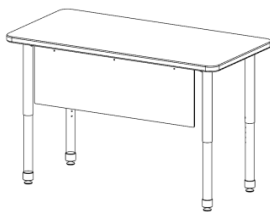

Table Width

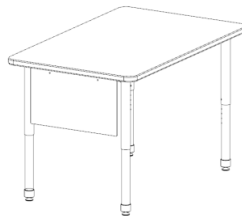

Table Depth

	Table Width				Table Depth		
	36" w	48" w	60" w	72" w	24" d	30" d	36" d
# of Brackets	2	3	4	5	N/A	2	2
12" h Screens	24.25" x 12"	36.25" x 12"	48.25" x 12"	60.25" x 12"	N/A	24.25" x 12"	24.25" x 12"
22" h Screens	24.25" x 22.5"	36.25" x 22.5"	48.25" x 22.5"	60.25" x 22.5"	N/A	24.25" x 22.5"	24.25" x 22.5"

**Other Discover Shapes**

**24" Screens may be used on the following shapes/sizes:**

3P3060 (3), AP2440 (2), AP3050 (2), BR2046 (2), EX3054 (2), SQ36 (4), SQ42 (4), WG3060 (3), Student Desks RC2026 and RC2034

**36" Screens may be used on the following shapes/sizes:**

HR2448 (1), SQ48 (4)

**60" Screens may be used on the following shapes/sizes:**

HR3672 (1)

**The following shapes support multiple sizes of screens:**

BR3072 (2 – 24" & 2 – 36"), TZ3060 (3 – 24" & 1 – 36")



## SCREEN INSTALLATION

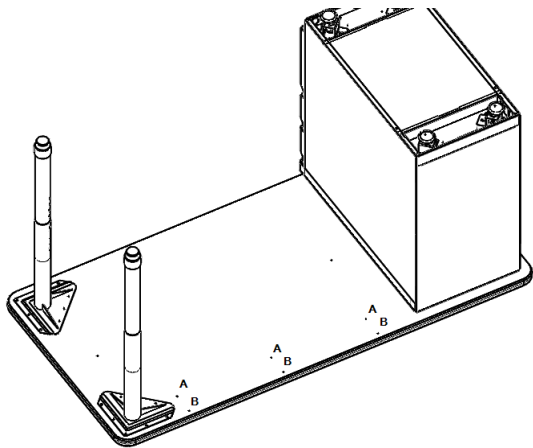

All Teacher desk tops come pre-drilled from the factory for installation of screen brackets. The approach side of the desk has two pre-drill locations depending upon desired screen application. See below for appropriate hole pattern.

<u>Application</u>	<u>Pre-Drill Location</u>
Modesty Screen (12" h)	A
Privacy Screen (12" h)	B
Combination Screen (22" h)	B

Note: Discover Shape Tables are NOT pre-drilled See Figure 1 for recommended hole locations.

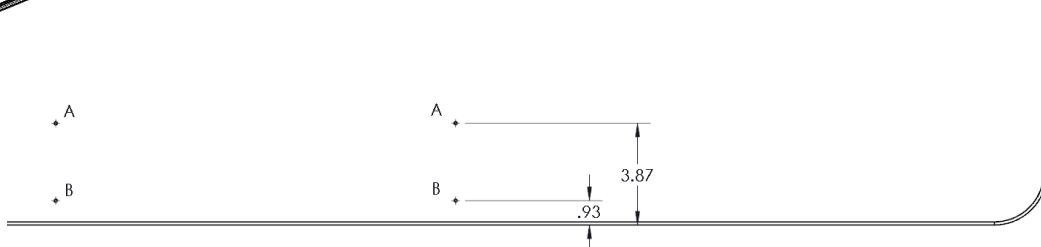

**Figure 1** Recommended Pre-Drill on Rectangular Tables Only  
 Note: not all tables support above pre-drill locations

1. Once proper pre-drill location is determined and with the desk in the upside down position, attach each L-bracket to top using the included #12 x 3/4" Philips head wood screws. **NOTE:** It may be easier to not fully tighten screws as this will help with alignment.
2. Using a 5/32" allen wrench and included button head machine screws, attach screen to each of the L-brackets.

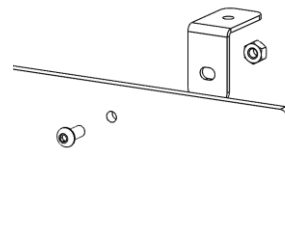
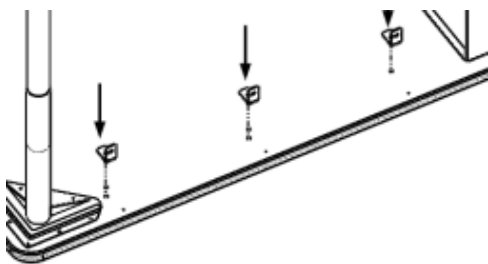

3. Tighten all fasteners and if needed, use two installers to flip the desk or table to the in-use position

**DISCOVER SHAPE TABLES & SCREENS | Planning Drawings**

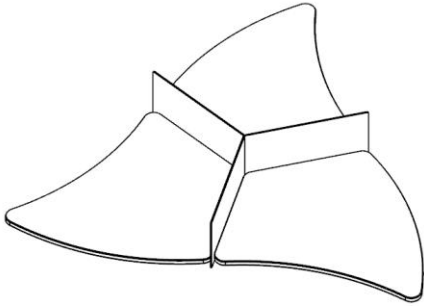

**APERATURE 24x40**

- QTY 3 - DTT-AP2440 – APERTURE TABLES
- QTY 3 - TA-SA1224 - SINGLE SCREEN 12"X24.25"

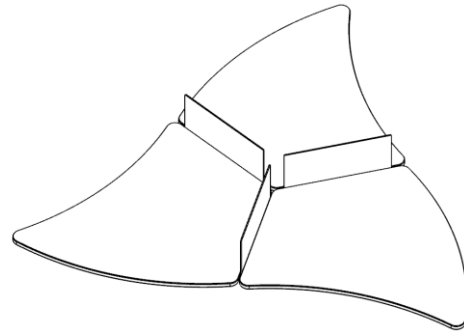

**APERATURE 30x50**

- QTY 3 - DTT-AP3050 - APERTURE TABLES
- QTY 3 - TA-SA1224 - SINGLE SCREEN 12"X24.25"

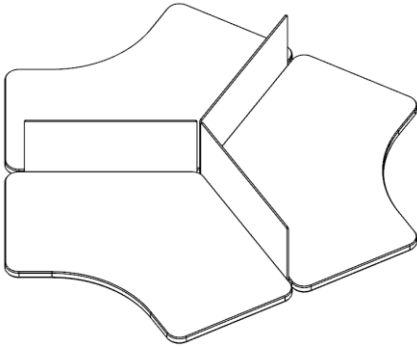

**BOOMERANG 20x46**

- QTY 3 - DTT-BR2046 - BOOMERANG TABLES
- QTY 3 - TA-SA1224 - SINGLE SCREEN 12"X24.25"

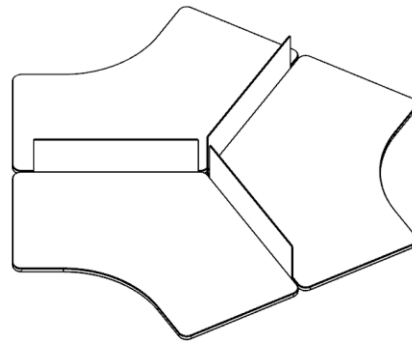

**BOOMERANG 30x72**

- QTY 3 - DTT-BR3072 - BOOMERANG SHAPE TABLES
- QTY 3 - TA-SA1236 - SINGLE SCREEN 12"X36.25"

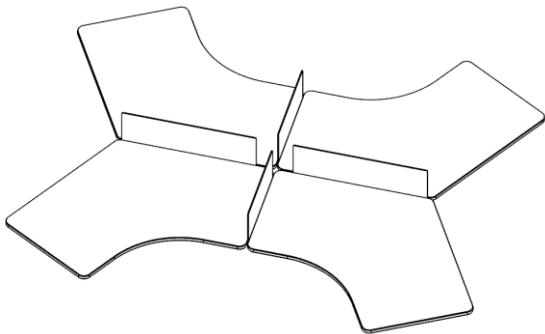

**BOOMERANG 30x72**

- QTY 4 - DTT-BR3072 - BOOMERANG SHAPE TABLES
- QTY 2 - TA-SA1236 - SINGLE SCREEN 12"X36.25"
- QTY 2 - TA-SA1224 - SINGLE SCREEN 12"X24.25"